

SINGLE VALVE

DOUBLE VALVE

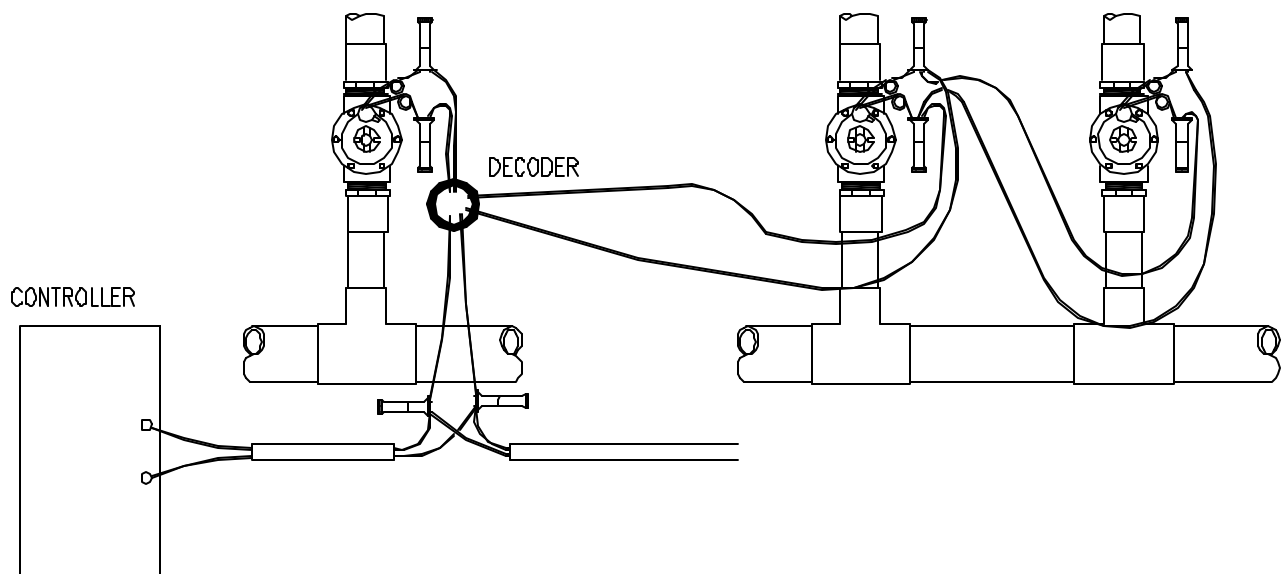

NOTE: THE SECONDARY WIRE PATH FROM THE DECODER TO VALVE

18/2 = 150'

14/2 = 300'

IF OPERATING TWO VALVES PER DECODER ADDRESS THE TOTAL DISTANCE OF EACH VALVE MUST BE ADDED TOGETHER AND NOT EXCEED THE LIMITS SET.

flow master LD200 Decoder